

Series characteristics

Series	EWXX-1	 		
Type of construction	Open frame			
Ingress protection index	IP00			
Ambient operating temperature min. ~ max.	-5 ... +30°C			
Operational temperature rise	+ 55°C			
Operating humidity RH non-condensing	20 ~ 90%			
Operating altitude above sea level max.	≤ 1000 M			
Protective earth class	Class 1			
Cooling class	AN (Air Natural)			
Insulation class	Class B 130°C			
Short-circuit protection (external device required)	Input "T" fuse or "D" MCB			
Over-load protection (external device required)	Output "F" fuse or "C" MCB			
Isolation Pri/Earth, Pri/Sec, Sec/Earth	4.0kV			

Product specifications

Product	Prim Input Volt (vac)	Prim Input Current F/L (A)	Prim in-rush current F/L (A)	Sec Output volt F/L (vac)	Sec output volt O/C (vac)	Sec Output Current F/L (A)	Sec Overload device value (A)	Total power rating (V.A)	Freq- uency range (Hz)	Max overload capacity (%)	Short-circuit voltage (%)	Core Excite (mag) Current (A)	Normal Loss (W)	Isolation Class	Manufactured Standard ASNSZ
EW10	230	0.022	0.50	12	14.8	0.42	F0.50	5	47 ~ 63	115	14.0	0.011	1.3	Safety isolating	ASNSZ 61558.2.6
EW11	230	0.070	1.58	12	14.2	1.33	F1.5	16	47 ~ 63	115	15.2	0.017	2.0	Safety isolating	ASNSZ 61558.2.6
EW12	230	0.130	2.93	12	14.1	2.50	F3.0	30	47 ~ 63	115	13.0	0.027	3.1	Safety isolating	ASNSZ 61558.2.6
EW13	230	0.220	4.95	12	14.0	4.17	F5.0	50	47 ~ 63	125	16.0	0.042	4.8	Safety isolating	ASNSZ 61558.2.6
EW14	230	0.440	9.90	12	13.6	8.33	F10.0	100	47 ~ 63	125	9.1	0.043	5.0	Safety isolating	ASNSZ 61558.2.6
EW16	230	0.870	19.6	12	12.7	16.7	F20.0	200	47 ~ 63	125	5.6	0.080	9.2	Safety isolating	ASNSZ 61558.2.6
EW17	230	0.022	0.50	24	29.6	0.21	F0.25	5	47 ~ 63	115	14.0	0.011	1.3	Safety isolating	ASNSZ 61558.2.6
EW18	230	0.070	1.58	24	28.4	0.67	F0.75	16	47 ~ 63	115	14.2	0.017	2.0	Safety isolating	ASNSZ 61558.2.6
EW19	230	0.130	2.93	24	28.3	1.25	F1.5	30	47 ~ 63	115	10.9	0.027	3.1	Safety isolating	ASNSZ 61558.2.6
EW20	230	0.220	4.95	24	27.9	2.08	F2.5	50	47 ~ 63	125	7.4	0.037	4.3	Safety isolating	ASNSZ 61558.2.6
EW21	230	0.440	9.90	24	27.2	4.17	F5.0	100	47 ~ 63	125	10.7	0.043	5.0	Safety isolating	ASNSZ 61558.2.6
EW23	230	0.870	19.6	24	25.3	8.33	F10.0	200	47 ~ 63	125	7.0	0.080	9.2	Safety isolating	ASNSZ 61558.2.6
EW25	230	0.070	1.58	115	125.0	0.14	F0.15	16	47 ~ 63	115	15.2	0.017	2.0	Isolating	ASNSZ 61558.2.4
EW26	230	0.130	2.93	115	125.0	0.26	F0.30	30	47 ~ 63	115	9.9	0.027	3.1	Isolating	ASNSZ 61558.2.4
EW27	230	0.220	4.95	115	125.0	0.44	F0.50	50	47 ~ 63	125	11.9	0.036	4.1	Isolating	ASNSZ 61558.2.4
EW28	230	0.440	9.90	115	125.0	0.87	F1.0	100	47 ~ 63	125	8.9	0.043	5.0	Isolating	ASNSZ 61558.2.4
EW29	230	0.870	19.6	115	121.1	1.74	F2.0	200	47 ~ 63	125	5.3	0.081	9.3	Isolating	ASNSZ 61558.2.4
EW30	230	1.300	29.3	115	121.7	2.61	F3.0	300	47 ~ 63	125	5.1	0.112	12.9	Isolating	ASNSZ 61558.2.4
EW32	400	0.040	0.90	230	242.0	0.07	F0.075	16	47 ~ 63	115	15.3	0.010	2.0	Isolating	ASNSZ 61558.2.4
EW33	400	0.130	2.93	230	242.0	0.22	F0.25	50	47 ~ 63	125	11.9	0.021	4.2	Isolating	ASNSZ 61558.2.4
EW34	400	0.250	5.63	230	242.0	0.44	F0.50	100	47 ~ 63	125	9.0	0.029	5.8	Isolating	ASNSZ 61558.2.4
EW35	400	0.500	11.25	230	242.0	0.87	F1.0	200	47 ~ 63	125	5.4	0.046	9.2	Isolating	ASNSZ 61558.2.4
EW36	400	0.750	16.88	230	243.7	1.30	F1.5	300	47 ~ 63	125	5.0	0.065	13.0	Isolating	ASNSZ 61558.2.4
EW38	400	0.040	0.90	12	14.2	1.33	F1.5	16	47 ~ 63	115	16.2	0.017	3.4	Safety isolating	ASNSZ 61558.2.6
EW39	400	0.075	1.69	12	14.1	2.50	F2.5	30	47 ~ 63	115	14.0	0.016	3.2	Safety isolating	ASNSZ 61558.2.6
EW40	400	0.130	2.93	12	14.0	4.17	F5.0	50	47 ~ 63	125	15.4	0.024	4.8	Safety isolating	ASNSZ 61558.2.6
EW41	400	0.250	5.63	12	13.6	8.33	F10.0	100	47 ~ 63	125	12.6	0.030	6.0	Safety isolating	ASNSZ 61558.2.6
EW43	400	0.040	0.90	24	28.4	0.67	F0.75	16	47 ~ 63	115	14.6	0.010	2.0	Safety isolating	ASNSZ 61558.2.6
EW44	400	0.075	1.69	24	28.3	1.25	F1.5	30	47 ~ 63	115	11.8	0.015	3.0	Safety isolating	ASNSZ 61558.2.6
EW45	400	0.130	2.93	24	27.9	2.08	F2.5	50	47 ~ 63	125	14.0	0.021	4.2	Safety isolating	ASNSZ 61558.2.6
EW46	400	0.250	5.63	24	27.2	4.17	F5.0	100	47 ~ 63	125	11.3	0.031	6.2	Safety isolating	ASNSZ 61558.2.6
EW48	400	0.040	0.90	115	125.0	0.14	F0.15	16	47 ~ 63	115	15.4	0.010	2.0	Isolating	ASNSZ 61558.2.4
EW49	400	0.075	1.69	115	125.0	0.26	F0.30	30	47 ~ 63	115	12.9	0.015	3.0	Isolating	ASNSZ 61558.2.4
EW50	400	0.130	2.93	115	125.0	0.44	F0.50	50	47 ~ 63	125	13.8	0.021	4.2	Isolating	ASNSZ 61558.2.4
EW51	400	0.250	5.63	115	125.0	0.87	F1.0	100	47 ~ 63	125	11.0	0.029	5.8	Isolating	ASNSZ 61558.2.4
EW52	400	0.500	11.25	115	121.2	1.74	F2.0	200	47 ~ 63	125	5.1	0.046	9.2	Isolating	ASNSZ 61558.2.4
EW53	400	0.750	16.88	115	121.9	2.61	F3.0	300	47 ~ 63	125	5.1	0.065	13.0	Isolating	ASNSZ 61558.2.4

"T" fuse = time delayed fuse (slow blow) no rupture during inrush start-up
"C" MCB = fast trip

"D" MCB = time delayed MCB no trip during inrush start-up
F/L = full load current

"F" fuse = fast blow (normal blow)
O/C = open circuit no load

Terminations

Voltage	VA rating	Prim input termination	Prim input lead colours	Prim input lead length	Sec output termination	Sec output lead colours	Sec output lead length
12vac	5~50	-	-	-	Flying leads Appliance wire	Black - Black	250mm
24vac	5~50	-	-	-	Flying leads Appliance wire	White - White	250mm
115vac	16~300	-	-	-	Flying leads, Appliance wire	Orange - Orange	250mm
230vac	5	Flying leads Appliance wire	Blue - Brown	250mm	-	-	-
	16 ~ 300	Flying leads Appliance wire	Blue - Brown	250mm	Flying leads Appliance wire	Brown - Brown	250mm
400vac	16 ~300	Flying leads Appliance wire	Blue - Red	250mm	-	-	-

Schematic diagram

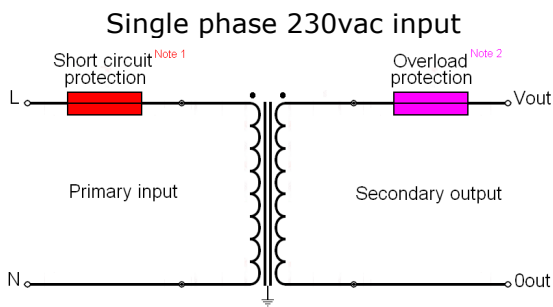

Note 1 - Primary input short circuit protection device external to transformer, installer to supply and fit. The protective device shall be rated to the maximum current rating of the wiring supplying the transformer. Recommend slow blow fuse or "D" curve circuit breaker.

Note 2 - Secondary output overload protection device external to transformer, installer to supply and fit. The protective device shall be rated to the capacity indicated on the transformer label and/or accompanying documentation. Recommend fast blow fuse or "C" curve circuit breaker.

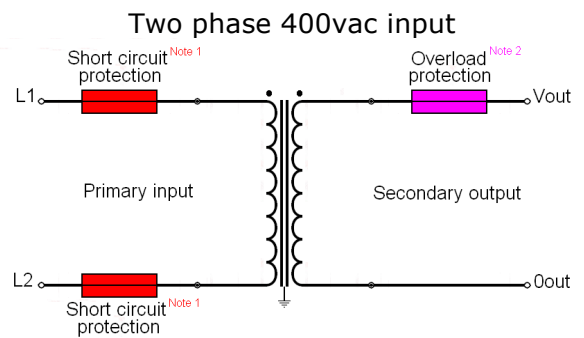

Note 1 - Primary input short circuit protection device external to transformer, installer to supply and fit. The protective device shall be rated to the maximum current rating of the wiring supplying the transformer. Recommend slow blow fuse or "D" curve circuit breaker.

Note 2 - Secondary output overload protection device external to transformer, installer to supply and fit. The protective device shall be rated to the capacity indicated on the transformer label and/or accompanying documentation. Recommend fast blow fuse or "C" curve circuit breaker.

Dimensions

Product VA rating	H Height (mm)	W Width (mm)	D Depth (mm)	Mounting Method	Mounting centres (mm)	Mounting fixings	Weight (kg)
5V.A	40	65	37	"U" Clamp	55 (Wc)	Slotted 3 x 5 mm	0.2
16V.A	47	57	50	"L" Feet	48 (Wc) x 40 (Dc)	Ø 4.5 mm	0.4
30V.A	55	66	54	"L" Feet	57 (Wc) x 39 (Dc)	Ø 4.5 mm	0.7
50V.A	64	78	60	"L" Feet	64 (Wc) x 47 (Dc)	Ø 5.5 mm	1.0
100V.A	64	78	76	"L" Feet	64 (Wc) x 64 (Dc)	Ø 5.5 mm	1.6
200V.A	96	115	81	"L" Feet	96 (Wc) x 62 (Dc)	Ø 5.5 mm	3.6
300V.A	96	115	87	"L" Feet	96 (Wc) x 68 (Dc)	Ø 5.5 mm	4.2

Drawings

Transformers rated 5 V.A

"U" clamp

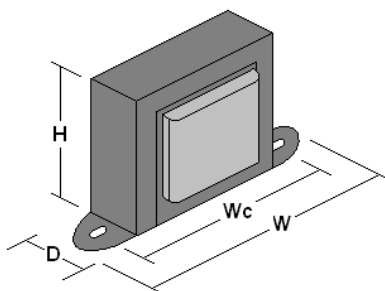

Transformers rated 16~300 V.A

"L" feet

